



WalkMed 350VL

Ambulatory Infusion Pump



Operation Manual
for the Clinician

IMPORTANT NOTICE

©2013 WalkMed, LLC.

All rights reserved. Printed in USA. WalkMed and the walking legs design are registered trademarks of WalkMed, LLC.

Disclaimer

The information in this manual is accurate and reliable as of the time of its release for this specific version of the pump. However, WalkMed, LLC reserves the right to change the specifications of the product described in this manual without notice at any time. As such, the descriptions and data included in this document may not be current if a different revision of the manual is used. Therefore, it is important that the user ensure they are using the most up to date revision of this manual.

Federal (USA) law restricts this device to sale by, or on the order of, a physician.

Not for Patient Use: This manual is intended for use by qualified healthcare professionals only. A certified, licensed healthcare practitioner must supervise all infusion therapies. An adequate level of proficiency must be demonstrated by caregivers and patients according to policies set by Clinical Facility.

Indications for Use

The WalkMed 350VL pump is indicated for intravenous, subcutaneous, arterial, enteral, and epidural infusion of: antibiotics, analgesics, chemotherapeutic agents, and other medications or fluids requiring precisely-controlled infusion rates.

Contraindications for Use

The WalkMed 350VL pump is contraindicated for: Infusion of blood and blood products, infusion of insulin, infusion of critical medications whose stoppage or interruption would cause serious injury or death. Use in ambulatory regimens by patients who do not possess the mental, physical, or emotional capability to operate the pump properly; or who are not under the care of a responsible individual.



WalkMed, LLC
14190 E. Jewell Ave, Unit 10
Aurora, CO 80012, USA
303-420-9569



INTRODUCTION

01	Features and Controls	4
	Pump Unit	4
	Accessories	6
	Pump Signals	7
	Keypad Function Table	8
02	Technical Specifications	9
03	Indications and Contraindications	11
04	Precautions	12

OPERATION INSTRUCTIONS

05	Removing and Attaching the Front Cover	17
06	Opening and Closing the Reservoir Cover	18
07	Inserting and Removing the Battery	19
08	Installing the Reservoir/Tubing Set	21
09	Programming the Pump	25
	Keypad Function Table	26
	Turn Pump Power On	28
	Enter Programming Mode	29
	Programming Basal Flow Rate	29
	Resetting Volume Delivered to Zero	32
	Programming Total Volume Limit	33
	Changing the Lock/Unlock	35
10	Delivering Medications	36
	To Prime Tubing Set	36
	To Start Delivery	37
	During Delivery	37
	To Stop Delivery	38
	Total Volume Limit Reached and End KVO	39
11	Using the Carrying Pouch	40
12	Discontinuing Use of the Pump	41

MAINTENANCE

13	Cleaning and Care	42
14	Functional Test Procedures	43
	Functional Verification Test	44
	Functional Verification Test Check-Off Form	46

TROUBLESHOOTING

15	Problem-Solving Procedures	47
	If a Problem Occurs	47
	Problem-Solving Table	48
16	Obtaining Service Assistance	50
17	Limited Warranty	52

TECHNICAL SPECIFICATIONS

18	Technical Description	54
	Electromagnetic Emissions	54
	Electromagnetic Immunity	55
	Key to Symbols	57

	Index	58
--	--------------	-----------

Pump Unit

1. Control keypad. Use to program, review, and change pump settings; and to control operation of the pump.
2. Display screen. Shows messages describing normal operation functions and alarm events.
3. Status light. Blinks green, yellow, or red to show pump operating status or system alert conditions.
4. Malfunction light. A continuous red light that shows when a system malfunction occurs, system alarms.
5. Battery compartment. One 9-volt alkaline battery fits here.

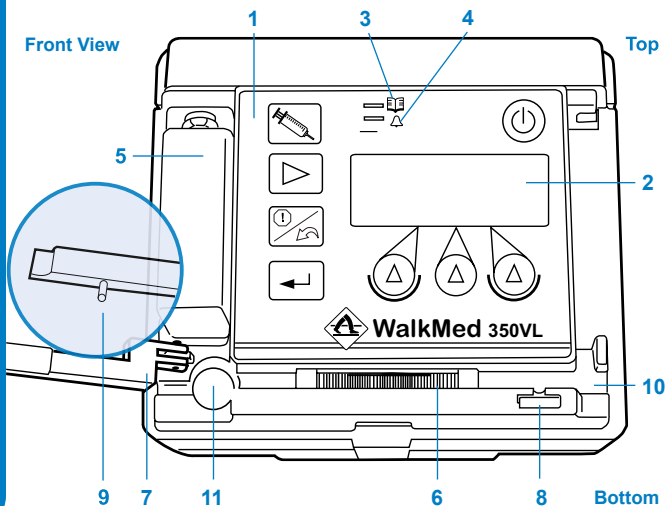

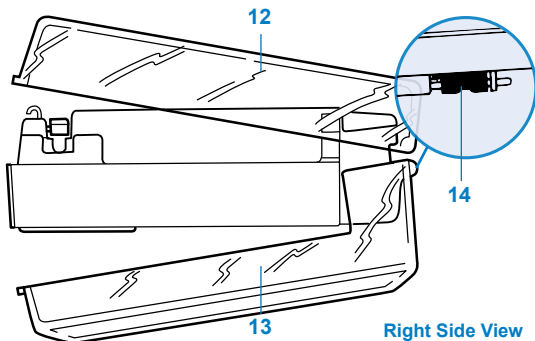

6. Pumping chamber. Applies mechanical pumping action to the tubing in order to deliver medications to the patient.
7. Clamp bar. Secures the elastic segment of the pump tubing into place in the pumping chamber.
8. Clamp bar release. Press to release clamp bar.
9. Clamp bar lock pin. Locks the clamp bar securely in place.
10. Elbow seat. The right-angle elbow fitting of the pump tubing set fits here.
11. Pressure cell seat. The pump tubing set pressure cell diaphragm fits here to enable proper functioning of the pump occlusion alarm.
12. Front cover. Protects the control keypad during pump use and storage.
13. Reservoir cover. Holds the reservoir bag in place during use.
14. Reservoir cover hinge release. Use to remove the reservoir cover from the pump.

Standard Pump Accessories

The WalkMed Pump is packaged with the following standard accessories:









- WM 350VL Infusion Pump
- Front Cover
- Small Reservoir Cover
- Large Reservoir Cover
- Operation Manual (this document)
- Carrying Pouch
- 9-volt Battery
- Clinician Quick Start Guide
- Patient Quick Reference Cards

Optional pump accessories:

- Locking Reservoir Covers
- Disposable Carrying Pouch & Belt
- Adjustable Waist Belt
- 1 Liter Carry Case
- Back Pack









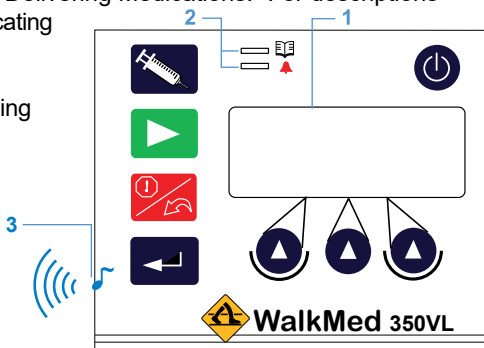

Pump Signals



The WalkMed 350VL pump provides visual and audible information to the user during normal operation and in the event of system problems. The pump communicates this information by 3 types of signals:

1. **Display screen.** The front panel screen shows messages describing normal operation functions and alarms.
2. **Lights.** Two lights labeled   and   are located on the pump front panel. Depending on the operating function or alarm being signaled, the   light may blink green, yellow, or red. The   light comes on in a continuous red when a System Malfunction occurs.
3. **Audio tones.** The pump emits beep tones singularly, continually, or in various patterns, depending on the operating function or alarm being signaled.

Signals of normal operation are described where appropriate in Chapter 10 “Delivering Medications.” For descriptions of signals indicating problems, see Chapter 15, “Problem-Solving Procedures.”



Control Key	Function
Power 	Press to turn pump power on or off.
Start 	Press to start medication delivery.
Stop/Undo 	Press to stop medication delivery. Press to undo a new number setting while in programming mode changing rates. Press to stop prime.
Prime 	Press to enter Prime mode, then press  within 7 seconds to prime.
Enter 	Press to save setting and advance to next programming screen.
	Press any key to change setting in screen display above that key.
	Press any 2 keys together to clear rate setting to zero, and to change decimal point position.
Status 	System Alerts
Malfunction 	System Alarms

Note: ,  and  keys are inactive during medication delivery, regardless of lock status.

Dimensions L x W x H:	11.2 x 10.2 x 3.8 cm/4.4 x 4.0 x 1.5 inches (includes front cover)
Weight:	360 g/12 oz. (Includes battery and front cover)
Drive mechanism:	DC motor, microprocessor-controlled, linear peristaltic drive mechanism
Infusion mode:	Continuous (basal) rate infusion (with or without KVO infusion)
Accuracy:	± 5%
Basal flow rate range:	0.10 to 19.99 ml/hr (in resolution of 0.01 ml) 00.1 to 30.0 ml/hr (in resolution of 0.1 ml)
Total volume delivered:	0.00 - 1999 (automatic decimal point adjustment on display). After reaching 1999 ml the volume delivered display restarts at 0.00 ml.
Total volume limit:	1 to 1999 ml resolution of 1 ml
End of infusion KVO rates:	Basal Rate ≥ 1.0 ml/hr = 0.5 ml/hr Basal Rate < 1.0 and ≥ 0.2 ml/hr = 0.2 ml/hr Basal Rate < 0.2 ml/hr = Basal Rate
Power source:	One (1) 9-volt alkaline battery (Duracell® brand MN1604, Medline MPHB, or equivalent).
Typical battery capacity:	- 450 ml at 1 ml/hr - 18.7 Days - 650 ml at 10 ml/hr - 2.7 Days - 500 ml at 30 ml/hr - 0.7 Days
Reservoir bags:	Available reservoir sizes include 65, 150 and 250 ml.
Tubing sets:	Use only dedicated WalkMed pump tubing sets manufactured by WalkMed, LLC.

<p>Occlusion detection:</p>	<p>517 ±155 mmHg / 10 ±3 psi immediately distal to drive mechanism.</p> <p>If the occlusion is cleared while in delivery mode the pump will automatically cancel the alarm and resume delivery.</p> <p>Occlusion Detection Time</p> <table border="1" data-bbox="379 378 938 628"> <thead> <tr> <th data-bbox="379 378 581 529">Basal Rate ml/hr</th> <th data-bbox="581 378 783 529">Maximum Time for Occlusion Alert</th> <th data-bbox="783 378 938 529">Occlusion Bolus Volume</th> </tr> </thead> <tbody> <tr> <td data-bbox="379 529 581 579">0.1</td> <td data-bbox="581 529 783 579">55 Minutes</td> <td data-bbox="783 529 938 579">NA</td> </tr> <tr> <td data-bbox="379 579 581 628">15.0</td> <td data-bbox="581 579 783 628">37 Seconds</td> <td data-bbox="783 579 938 628">0.07 ml</td> </tr> </tbody> </table>	Basal Rate ml/hr	Maximum Time for Occlusion Alert	Occlusion Bolus Volume	0.1	55 Minutes	NA	15.0	37 Seconds	0.07 ml
Basal Rate ml/hr	Maximum Time for Occlusion Alert	Occlusion Bolus Volume								
0.1	55 Minutes	NA								
15.0	37 Seconds	0.07 ml								
<p>Operating environment:</p>	<p>2° to 50° C (35° to 122° F) Storage: -10° to 50° C (14° to 122° F)</p>									
<p>Alerts:</p>	<ul style="list-style-type: none"> - Low battery - Not Delivering - Clamp Bar open - Occlusion - End of Infusion - KVO - Total Volume Limit reached 									
<p>Alarms:</p>	<ul style="list-style-type: none"> - Under-Delivery - Over-Delivery - System Malfunction - Depleted battery 									
<p>Memory Backup:</p>	<p>The last entered settings are retained in the pump memory.</p>									

Indications for Use

The WalkMed 350VL pump is indicated for intravenous, subcutaneous, arterial, enteral, and epidural infusion of:

- antibiotics
- analgesics
- chemotherapeutic agents
- and other medications or fluids requiring precisely-controlled infusion rates

Contraindications for Use

The WalkMed 350VL pump is contraindicated for:

- Infusion of blood and blood products
- Infusion of insulin
- Infusion of critical medications whose stoppage or interruption would cause serious injury or death
- Use in ambulatory regimens by patients who do not possess the mental, physical, or emotional capability to operate the pump properly; or who are not under the care of a responsible individual

Precautions

- Before use, the user must become thoroughly familiar with the information contained in the device operating instructions.
- **Danger:** Do not use the WalkMed 350VL pump in the presence of flammable anesthetics or explosive gases. The WalkMed 350VL pump presents a possible explosion hazard if used in the presence of such materials.
- Before connecting to the patient, purge all air from the infusion lines.
- The WalkMed 350VL pump does not have an air-in-line detection alarm. Periodic visual inspection for the presence of air in the infusion lines during use is recommended.
- Do not operate the WalkMed 350VL pump in the Prime function while connected to a patient. In the Prime function, the pump infusion rate is equal to or greater than 30.0 ml/hr. Using the pump in the Prime function while connected to a patient may cause over-infusion of medications.
- Do not use the WalkMed 350VL pump in the presence of high-intensity magnetic fields (e.g., MRI scanners). Exposure to strong magnetic fields may adversely affect the pump's infusion accuracy, possibly causing over-infusion of medications to the patient.
- Do not drop the WalkMed 350VL pump, strike it against hard objects, or place heavy weight on top of it. If the pump is dropped or damaged, test it thoroughly before use to assure that it is functioning properly. Use of a damaged pump may cause over-infusion or under-infusion of medications to the patient.

- The WalkMed 350VL pump clamp bar must be securely closed by fully engaging the clamp bar lock pin so that an audible “click” sound is heard. Before using the pump, confirm secure closure of the clamp bar by pulling up firmly on the end of the bar with a thumb or index finger. The clamp bar should open only when the lock pin is released. Failure to securely close the clamp bar may cause over-infusion or under-infusion of medications to the patient.
- Always clamp the tubing between the WalkMed 350VL pump and the patient’s access device before opening the pump clamp bar. Uncontrolled fluid flow can occur when the administration set is not clamped before opening the clamp bar; or is not properly installed in, or is removed from, the pump. Uncontrolled fluid flow may cause over-infusion of medications to the patient.
- The WalkMed 350VL pump must be maintained according to the instructions given in this operation manual. Failure to adhere to the recommended maintenance instructions may damage the pump, making it inoperable or causing it to malfunction.
- Medications or fluids infused by the WalkMed 350VL pump must be prescribed by the physician. It is the responsibility of the clinician using this pump to ensure that the medications or fluids are used only according to the physician’s infusion therapy prescription.
- As with any programmable infusion pump, before starting medication delivery, check to ensure that the programmed infusion settings are appropriate for the selected application.

- As with any infusion system, examine the fluid pathway connections for damage or leaks. Leakage may cause blood or fluid precipitation/loss. Continue to observe for leaks during use.
- The WalkMed 350VL pump flow rate and occlusion sensitivity may vary according to the administration set used. Use only those sets recommended for use with the WalkMed 350VL pump.
- A security code may be keyed-in to lock the WalkMed 350VL pump's infusion programming function. This code is designed to allow programming access to the clinician only, and must not be given to the patient. Tampering with programmed settings by a patient possessing the security code may cause over-infusion or under-infusion of medications to the patient.
- Do not sterilize or autoclave the WalkMed 350VL pump, pump tubing set, or pump reservoir. Subjecting them to sterilization or autoclaving may damage them, making them inoperable or causing them to malfunction.
- The WalkMed 350VL pump is not waterproof. Do not immerse the pump in water or other fluids. Do not allow water or other fluids to enter the pumping chamber or battery compartment. Entry of fluid into the pump may damage it, making it inoperable or causing it to malfunction. If the pump gets wet, have it serviced before reuse. When showering or bathing, the patient should place the pump in the carrying pouch and keep the pump out of contact with the water.

- Do not attempt to disassemble or repair the WalkMed 350VL pump. Refer all service to an authorized WalkMed service center.
- Do not use the WalkMed 350VL pump if you suspect it may have been damaged or is not operating properly.
- Always keep the front cover installed on the WalkMed 350VL pump during use and storage to prevent damage to the battery terminals, clamp bar release, and keypad. Such damage could make the pump inoperable or cause it to malfunction.
- The WalkMed 350VL pump measures for line occlusion only between the pump and the patient. The occlusion alarm will sound only if occlusion occurs between the pump and the patient. The pump does not measure or alarm for line occlusions that may occur between the reservoir bag and the pump. Always check for possible line occlusions (e.g., a closed clamp) between the reservoir bag and pump during use. An occluded line may cause under-infusion or non-infusion of medications to the patient.
- As with any sterile product, use aseptic technique when handling the dedicated WalkMed 350VL pump tubing set and reservoir bag.
- Do not twist the elastic segment of the dedicated WalkMed 350VL pump tubing set when installing it into the pump. Twisting of the elastic segment may cause flow inaccuracy, possibly resulting in under-infusion of medications to the patient.

- Refer to the infusion system disposable product labeling for instructions on preparation of that product for use.
- Patients using the WalkMed 350VL pump in ambulatory regimens must be instructed in its proper use.
- Do not use sharp objects to depress the control keys on the WalkMed 350VL pump keypad. Doing so may damage the keys, possibly making the pump inoperable or causing it to malfunction.
- As with any infusion system, medications or fluids may interact with the plastic components of the reservoir/ tubing sets, possibly causing damage or leaks. Before use, consult the pharmaceutical manufacturer's precautions and guidelines for the medications or fluids being used with the WalkMed 350VL pump.
- Federal (USA) law restricts this device to sale by, or on the order of, a physician.
- "Y" injection sites should not be used.
- Appropriate catheters and medications must be used according to approved device and medication labeling.
- Recommended use of epidural route is to provide anesthesia or analgesia for periods up to 96 hours.

To Remove Front Cover

1. Pull back latch with finger and remove top cover. The cover separates completely from the pump.

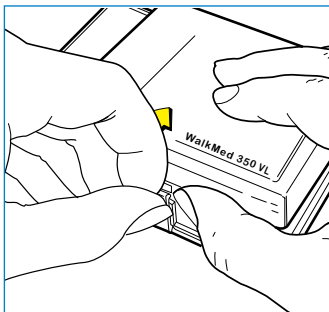

To Attach Front Cover

1. Orient the cover so that the frosted area of the cover is over the battery.
2. Insert the top of the cover into the groove at the top of the pump.
3. Push on the cover tabs at the bottom to snap the cover securely into the latch.

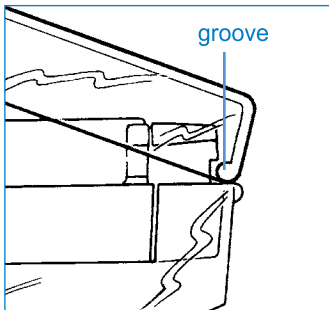

18 **To Open Reservoir Cover**

1. Place fingers on the top of the reservoir cover and pull back on the reservoir cover latch.
2. Open the reservoir cover by lifting up with thumb.

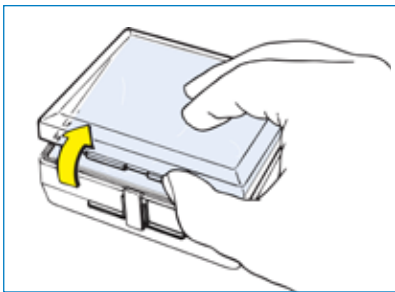
**To Close Reservoir Cover**

1. Push the reservoir cover shut until the latch snaps onto the front cover tab.

Check to make sure that the reservoir bag and tubing are not pinched by the closed cover.

**To Remove Reservoir Cover**

1. Slide the hinge release in toward the pump middle to retract the hinge release pin. When the pin is fully retracted, the cover is released and can be removed.

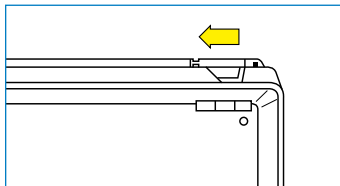

Battery Specification

Battery life is specified using a Duracell® brand MN1604, Medline MPH9 9-volt alkaline battery or equivalent.

To Insert Battery

1. Remove the front cover from the pump.

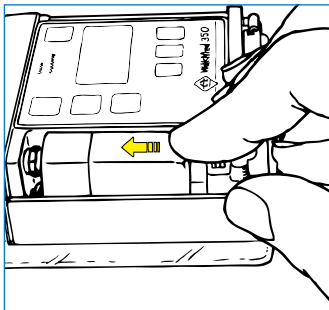
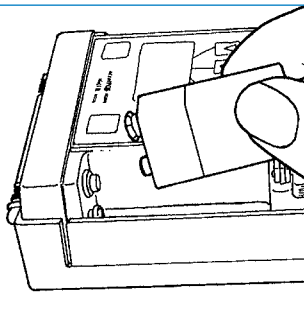

2. Match the terminals on the battery to the terminals in the pump battery compartment.
3. Push the battery up to snap it into place.

Note:

Wait approximately 15 seconds between removing the battery and installing the new battery, to allow the pump to turn on properly.

To Remove Battery

1. Remove the front cover from the pump.
2. Stop medication delivery and then turn the pump power off.
3. Place your thumb on top of the battery, and push down and away from the terminals.

Once the battery is disconnected, lift the battery out of the battery compartment.

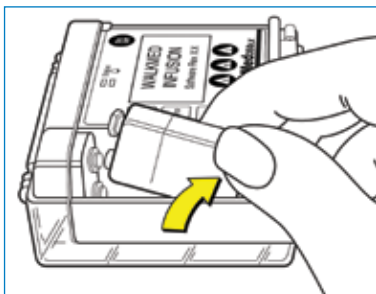
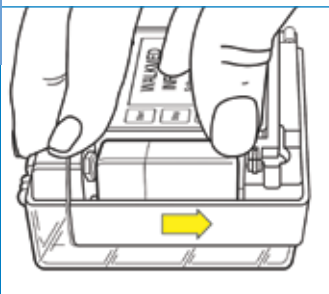

4. Dispose of the battery according to the battery manufacturer's recommendations and in accordance with applicable environmental regulations.

To Install Reservoir/Tubing Set

1. Prepare the reservoir and tubing set for installation in the WalkMed 350VL pump.

Note:

For instructions on preparing the dedicated reservoir and pump tubing set, refer to the instructions on the product packaging.

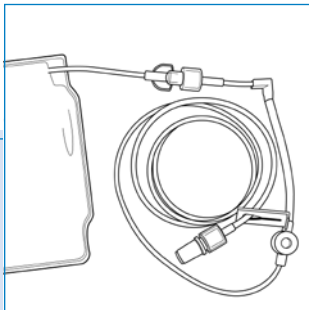

2. Remove the pump's front cover.
3. Open the pump's reservoir cover so that the cover and pump lay flat on your work surface.
4. Place the reservoir bag in the cover so that the tubing extends into the tubing set path on the right side of the pump.

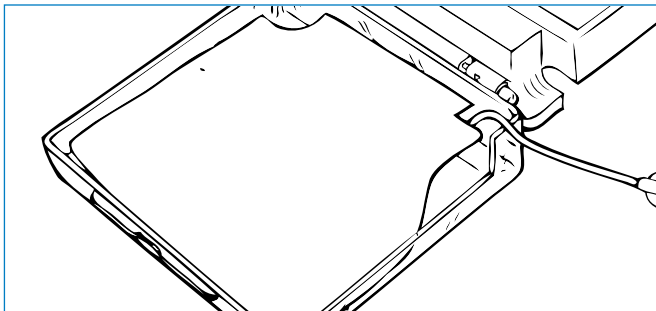

5. Leaving the reservoir cover in place, move the pump back onto the cover. Push down until the cover snaps onto the pump.

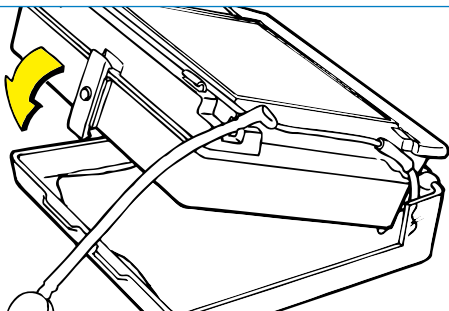

This method is recommended to ensure that the reservoir bag is completely inside the cover and that the bag and tubing are not pinched by the closed cover.

6. Open the clamp bar by pulling back from the clamp bar release on the bottom front of the pump and moving the clamp bar up and to the left.

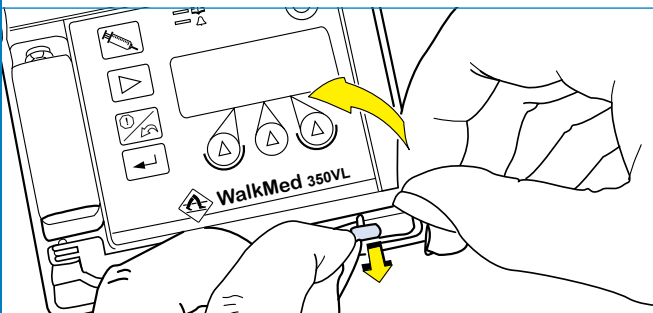

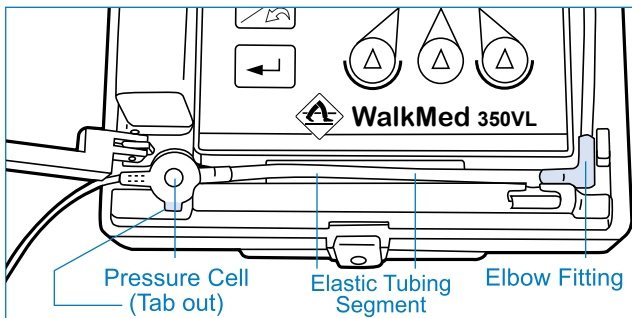

7. Insert the right-angle elbow fitting of the tubing into the elbow seat on the pump.
8. Insert the elastic tubing segment into the pumping chamber, and the pressure cell into the pressure cell seat to the left of the chamber, with the pressure cell tab pointing out.



Avoid twisting the elastic tubing segment.

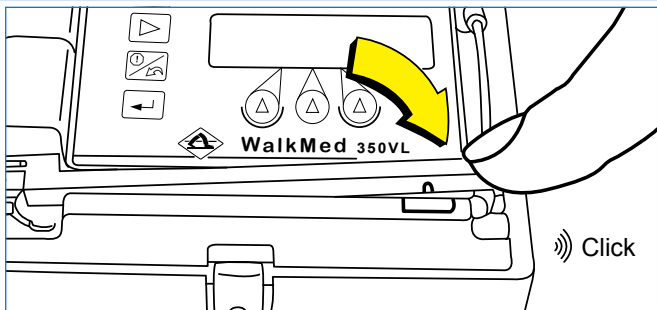

9. Close the clamp bar so that it locks fully with an audible “click” sound.

Closing the clamp bar places the elastic tubing segment in contact with the pumping mechanism. To ensure proper medication delivery, always close the clamp bar until it fully engages the lock pin with an audible “click” sound. Verify proper closure by pulling up firmly on the end of the clamp bar with your thumb or index finger.





Important:

The front cover should be re-attached after the pump has been prepared for use and medication delivery started.

PROGRAMMING THE PUMP















Programming Function Displays

Display	Function
<p style="text-align: center;">Idle</p> 	<p>This screen tells the user the pump is not in the delivery or programming modes.</p>
<p style="text-align: center;">Basal Flow Rate</p> 	<p>Used to set the flow rate.</p>
<p style="text-align: center;">Volume Delivered</p> 	<p>This screen tracks the total volume of fluid that has been delivered.</p>
<p style="text-align: center;">Total Volume Limit</p> 	<p>Used to set the amount of fluid to be infused.</p>
<p style="text-align: center;">Lock/Unlock</p> 	<p>This section indicates the Lock/Unlock status.</p>

Note:

The pump must be in the Unlocked mode to perform any programming functions.

Control Key	Function
Power 	Press to turn pump on or off.
Start 	Press to start medication delivery.
Stop/Undo 	Press to stop medication delivery. Press to undo a new number setting while in programming mode changing rates. Press while in programming mode to return to basal flow rate screen. Press to stop prime.
Prime 	Press to enter prime mode, then press  within 7 seconds to prime.
Enter 	Press to enter the programming loop. Press to save setting and advance to next programming screen.
Value 	Press any key to change the corresponding value.
 + 	Press any 2 value keys together to reset display. Press any 2 value keys together when the flow rate reads zero to move the decimal point.

Note: ,  and  keys are inactive during medication delivery, regardless of lock status.

28 Turning Pump Power On

To Turn Pump Power On:

Press and hold the  key until the display sequence begins.

Power-On Display Sequence

Each time the pump power is turned on, information displays automatically, scrolling to the **Idle** screen.

Press the enter key  to enter the programming loop.

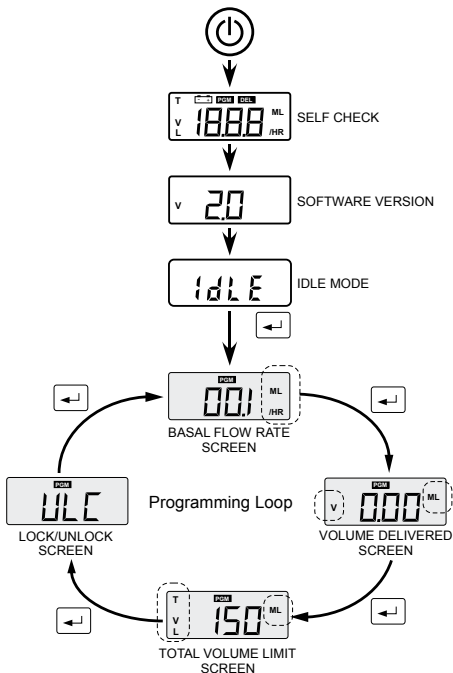



Enter Programming Mode

From the Idle display press the  key to enter the programming mode.

Programming Basal Flow Rate



Basal Flow Rate screen can be set between 0.1 to 30.0 ml/hr.

1. Set the Basal Flow Rate to Zero by pressing any  +  keys together.

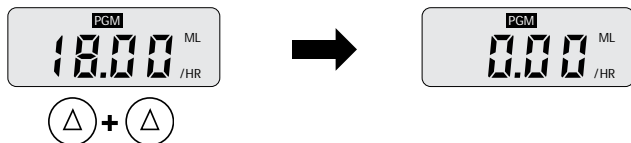

Note:

The pump is programmable in two ranges:

- 0.10 – 19.99 ml/hr can be programmed to 2 decimal points.
- 00.1 – 30.0 ml/hr can be programmed to 1 decimal point.

The pump cannot be set to less than 0.1 ml/hr.

2. Change the decimal point position by pressing any Δ + Δ keys together a second time.

Note:

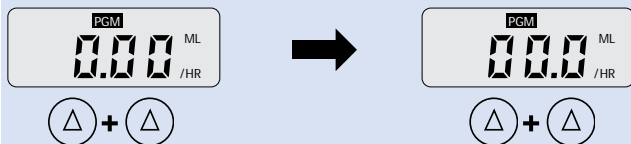

The pump must be zeroed to change the decimal point position.

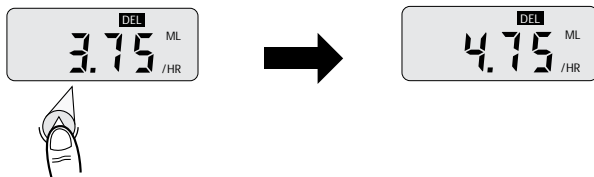

3. To set or change the Basal Flow Rate, press each Δ key to increase the value located above that key until the desired basal flow rate is displayed.



Example: Basal Flow Rate is 3.75 ml/hr. A new Basal Flow Rate of 4.75 ml/hr is needed. Press the Δ key under the "3" until the number "4" displays.

If an error in data entry has occurred press the  key to undo any entry prior to pressing the  key.

4. Press the  key to accept the new setting and move to the Volume Delivered display screen.

Note:

Prior to pressing the  key, it is recommended that the clinician scroll through all the program settings to verify pump is programmed properly and meets the desired regimen.

Resetting Volume Delivered To Zero





The Volume Delivered screen tracks the infused volume.

The Volume Delivered counter should be reset between therapies.

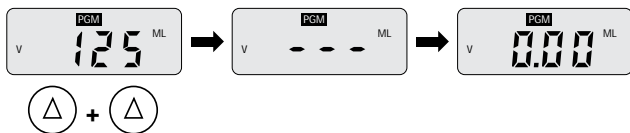
1. Reset the Volume Delivered counter to zero by pressing any 2 value keys together. The pump will display three dashes followed by 0.00.



Press the  key prior to pressing the  key to restore the cleared volume delivered amount.

2. Press  key to accept the reset Volume Delivered and advance to the Total Volume Limit screen.

If the Volume Delivered display is not reset, the volume display will count up to 1999 ml. After reaching 1999 ml the Volume Delivered display restarts at 0.00 ml.

Note:

Prior to pressing the  key, it is recommended that the clinician scroll through all the program settings to verify pump is programmed properly and meets the desired regimen.

Programming Total Volume Limit

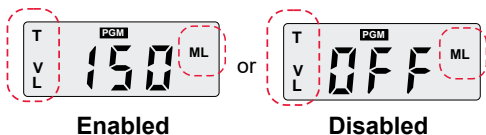

This function can be disabled. When enabled this function sets a limit for the amount of drug infused, followed by a 4 hour KVO infusion at end of delivery.

Go to page 39 for KVO information.



Note:

The pump is programmable from 1 to 1999 ml.

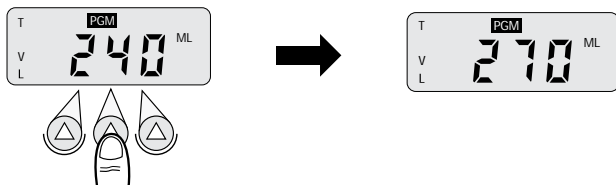
- To change the Total Volume Limit, press each Δ key to increase the number located above that key until the desired Total Volume Limit is displayed. Each press will advance the number by one and a beeping sound will be heard.



Example: The Total Volume Limit is currently set at 240 ml. A new Total Volume Limit of 270 ml is needed. Press the Δ key under the “4” until the number “7” displays.

Press the  key to undo any entry prior to pressing the  key.

- Press the  key to accept the new setting and move to the Lock/Unlocked display screen.

Note:

Setting the value to OFF disables the Total Volume Limit function.

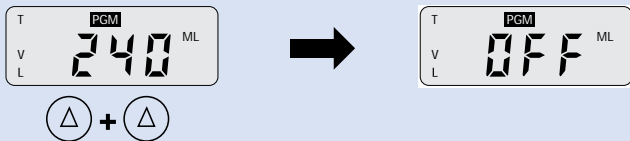

Set the Total Volume Limit to OFF by pressing any 2 keys together.

**Note:**

Prior to pressing the  key, it is recommended that the clinician scroll through all the program settings to verify pump is programmed properly and meets the desired regimen.

Lock/Unlock Keys



1. Press any  key, the pump will display all zeros. Press each  key to increase the number until the Access Code is displayed. **NOTE:** The access code is only available to medical professionals through WalkMed part number 204878.

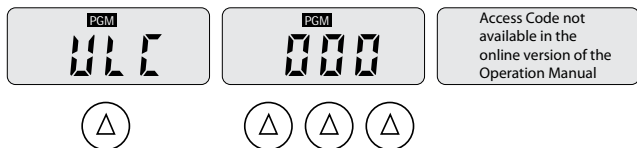

ACCESS CODE

Access Code not available in the online version of the Operation Manual

2. Press the  key and the pump display will momentarily display the Lock/Unlock mode that the pump is currently set to and advance to the Basal Flow Rate screen.

Note:



If the wrong access code is entered, two beeps will be heard and the pump display will return to the LOC or ULC screen.

36 To Prime Tubing Set

The prime function is accessed from the program mode and cannot be activated while the pump is locked.

**Warning:**

Do not engage the prime function while the pump is connected to a patient.

1. Open the slide clamp on the tubing below the pressure cell.
2. Press the  key, the display will change to the Prime screen. Press the  key and the pump will start to prime the tubing until 0.6 ml has been delivered.



The  key must be pressed within 7 seconds of entering the Prime screen or the display will change back to the Basal Rate Flow screen.

To stop the prime function at any time, press the  key. The display will change to the Basal Flow Rate programming screen.

3. Repeat step 2 as needed to prime the tubing set.



Note:

If the pump alerts due to an occlusion, (OCC), press the  key to silence the alarm, clear the occlusion and then repeat the Prime Instructions.

To Start Delivery

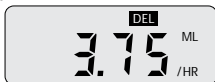
1. Connect the primed tubing set to the patient's IV access device.
2. Open the clamp on the patient's IV access device.
3. Press the  key to start medication delivery.



The   light will start blinking green. The display will read DEL and alternate between the Programmed Delivery Rate and Volume Delivered screens.





4. Attach the front cover to the pump.
5. For patient convenience and to protect the pump during use, place the pump in its carrying pouch.



For use instructions, see Chapter 11, "Using the Carrying Pouch."

During Delivery

During medication delivery, check for the following:

- The pump   light blinks green.
- The pump display screen reads DEL.
- The reservoir bag is emptying.
- There are no leaks in the tubing.
- There is no air in the reservoir bag or tubing.
- The tubing is not kinked or pinched.

Note:

, , and  keys are inactive during delivery.

To Stop Delivery

1. Press the  key.



This places the pump in Idle mode. In Idle mode the pump does not deliver.

The pump will remain in Idle mode until further action is taken.

Total Volume Limit Reached and End KVO

When the Total Volume Limit has been reached the pump will beep 3 times, the  blinks yellow and will continue delivery at one of the following End of Infusion KVO rates.

If Basal Flow Rate was programmed to:	KVO Flow Rate will be:
≥ 1.0 ml/hr	0.5 ml/hr
<1.0 ml/hr and ≥ 0.2 ml/hr	0.2 ml/hr
<0.2 ml/hr	Programmed Basal Flow Rate

The pump will continue to deliver for approximately 4 hours and scroll through the following three screen displays:





Example: If programmed Basal Flow Rate was ≥ 1.0 ml/hr

Note:

The pump will run at the KVO rate for 4 hours.

Example: If the pump is stopped after delivering in KVO mode for 1 hour and then started again without reprogramming any settings, the pump would run for an additional 3 hours before reaching END of KVO.

The pump may be stopped at any point during the KVO End of Infusion by pressing the  key. This will take the pump to the  screen.

To clear END alarm, see problem solving procedures on page 49.

Using the Carrying Pouch

1. Slip the WalkMed 350VL pump with reservoir bag into the pouch.

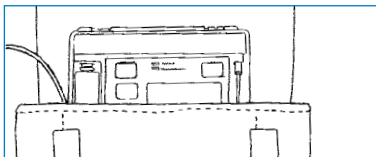

2. Close the pouch flap onto the velcro strips on the pouch front.

The tubing should come out of the opening on either side of the closed flap.

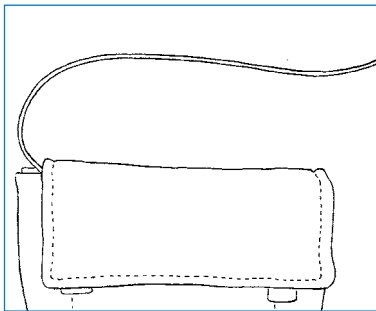

3. If the patient is to wear the pump, insert a belt through the pouch to make it more stable. Feed the belt through the belt loop on the back of the pouch.

Arrange the tubing to avoid kinking or twisting.

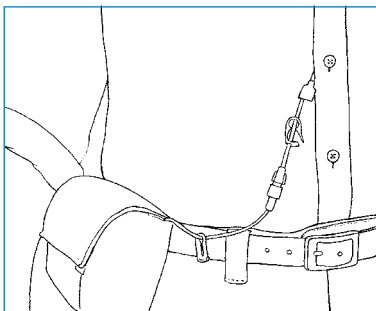

Help patients arrange their tubing to best fit their daily activities.

Discontinuing Use of the Pump

1. Stop medication delivery.
2. Close the slide clamp on the extension tubing below the pressure cell.
3. Disconnect the reservoir/tubing set from the patient's access device.
4. Turn the pump power off.
5. Open the clamp bar.
6. Remove the reservoir/tubing set from the pump.
7. Close the clamp bar.
8. Dispose of the reservoir/tubing set according your facility's policies and procedures, and in accordance with applicable environmental regulations.
9. Remove the battery from the pump. A battery left in the pump will slowly lose power during storage.
10. Clean the pump as needed, see Chapter 13 Cleaning and Care.
11. Re-attach the front cover on the pump.

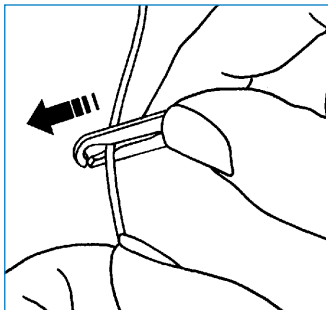

Note: Remove primary batteries if not likely to be used for some time.

Cleaning and Care

Clean the surfaces of the pump using a cloth dampened with water, mild cleanser, or a diluted solution of a mild dish-washing detergent. Avoid using caustic/acidic solvents such as paint thinner or lacquer remover.

Use the specially-designed carrying pouch available for the WalkMed pump to help protect the pump during storage and use.

Keep the front cover on the pump during storage and use. The front cover protects the control keypad, Clamp Bar Release and battery terminals from damage.

Functional Test Procedures

This chapter identifies the equipment and procedures necessary to perform the following test:

Functional Verification Test

Checks audible and visual information, control key operation, and alert indicators.

It is recommended that the Functional Verification Test be performed between each patient use by a qualified healthcare provider and that a periodic maintenance be performed annually by an Authorized Service Center. Use the master check off form in this chapter to document your results of the Functional Verification Test.

If a pump does not pass the Functional Verification Test, it must be returned to your authorized WalkMed service center for repair.

This pump contains no user-serviceable parts.

Functional Verification Test



Equipment Required:

- 60" WalkMed Pump Tubing Set
- 65 ml Reservoir Bag
- Operation Manual for the pump
- 9-volt alkaline battery

Equipment Set-Up:

1. Fill the reservoir bag with fluid and connect it to the pump tubing set.
2. Properly prime the pump tubing set assuring that all air is removed.
3. Load the reservoir bag and tubing set into the pump and close the clamp bar.
4. Install the battery in the pump.













Procedure:

1. Turn on the pump and verify all segments of the display are present and that the   light flashes yellow. Refer to the diagram below and the operating instructions for proper display segments:



Verify that the audio alert and  malfunction light operates for approximately 1 second during power-up.

2. Program the pump for a continuous flow rate of 5.0 ml/hr.
3. Occlude the tubing set, downstream of the pump, using the slide clamp.

4. Press the  key to initiate infusion. Verify that the  indicator flashes green approximately every 4 seconds.
5. Allow the pump to run until an occlusion alert is initiated. Verify that "OCC" is displayed and the  indicator flashes red and that the audio alert is active.
6. Press the  key and open the slide clamp on the tubing set.
7. Press the  key to initiate infusion.
8. Open the clamp bar and verify that a door open alert occurs. Verify that "d.OP" is displayed and that the audio alert is active.
9. Press the  key to silence the alarm and close the clamp bar.
10. Press the  key to initiate infusion.
11. Press the  key and verify that the pump stops infusing, that the  indicator flashes yellow approximately every 7 seconds, and that the audio alert beeps approximately every 7 seconds.
12. Press the  key. Verify that the pump  is displayed. Press the  key and verify the pump starts infusing.
13. Turn off the pump. Remove the tubing set and reservoir bag and the battery.

Functional Verification Test Check-Off Form

Copy Master – Do Not Remove or Fill-Out.

Pump Model:	_____
Serial No:	_____
Test Date:	_____
Test Time:	_____
Tested By:	_____
Confirmed by:	_____

Test	Specification	Pass/ Fail
Display verification at start-up	All segments present	
Status indicator illumination at start-up	Flashes yellow once, then red intermittently	
Malfunction indicator illumination at start-up	Operates for 1 second	
Audio alert signal at start-up	Activates	
Occlusion indicators activation	Display reads "OCC" Status indicator flashes red Audio alert activates	
Clamp Bar Open alert activation	Display reads "d.OP" Audio alert activates	
Delivery stop confirmation during infusion	Pump stops infusing Status indicator flashes Yellow Audio alert beeps every 7 seconds	
Prime mode activation	Display reads "Pri" Pump starts infusing when  is pressed	
Pump Passed/Failed		

Copy this master page and then fill-out the copies.

If a Problem Occurs





















1. Write down the message shown on the pump display screen.
2. Press the Stop key to temporarily silence the audio alarm.
3. Take corrective action as described in the Problem-Solving Table on the following pages.
4. If you cannot correct the problem using the Problem-Solving Table, contact your pump supplier for service assistance.









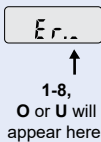

For more service information, refer to Chapter 16, "Obtaining Service Assistance."

Caution:

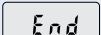
Do not attempt to disassemble or repair the WalkMed 350VL pump. Refer all service to an authorized WalkMed service center.

Problem Solving Table

Display Message	Sounds/ Lights	Condition	Corrective Action
 Or 	Sounds: Slow beeping Light:  Blinking yellow	Not Delivering	Press  key to start delivery. Press  key to silence alert for 5 minutes.
	Sounds: Slow beeping Light:  Blinking yellow	Low Battery	Press  key to silence alert. Replace battery within 30 minutes.
	Sounds: Continuous tone Light:  Continuous red	Depleted Battery	Remove depleted battery to silence alarm. Replace battery. Press  key to turn pump on. Press  key to restart.
	Sounds: Continuous tone Light:  Blinking red	Clamp Bar is Open	Press  key to silence alert. Close clamp bar. Press  key to restart.
	Sounds: Continuous tone Light:  Blinking red	IV Tubing Occlusion	Check tubing system for kinks and correct. Pump will resume delivery when line is cleared. Press  key to silence alert. Check tubing system for kinks and correct. Press  key to restart.

	<p>Sounds: Continuous tone</p> <p>Light:  Continuous red</p>	<p>System Malfunction</p>	<p>Write down Error message from display.</p> <p>Remove battery to silence alarm.</p> <p>Take pump out of service.</p> <p>Contact support with Error message.</p>
<p>Scrolling</p> 	<p>Sounds: Slow Beeping</p> <p>Light:  Blinking yellow</p>	<p>Total Volume Limit Reached</p>	<p>The pump will continue delivery at the KVO rate for approximately 4 hours.</p> <p>An audible alert will beep every 30 minutes.</p>
	<p>Sounds: Fast Beeping</p> <p> Blinking Red</p>	<p>End of KVO</p>	<p>Press  key to silence the alert.</p> <p>Press the  to turn the pump off.</p> <p>To clear END alert: Reset the Volume Delivered, increase the Total Volume Limit amount or set the Total Volume Limit to off.</p>
		<p>Failed Key in Keypad</p>	<p>Press the  to turn the pump off.</p> <p>Take pump out of service.</p>
	<p>Sounds: Continuous tone</p> <p>Light:  Continuous red</p>	<p>System Malfunction During Battery Install</p>	<p>Remove battery and wait 15 seconds before re-installing</p>

Caution:

Do not attempt to disassemble or repair the WalkMed 350VL pump. Refer all service to an authorized WalkMed service center.

WalkMed Authorized Service Centers**Medical Specialties Distributors**

800-967-6400

Intermountain BioMedical

801-565-8171

WalkMed, LLC

303-420-9569

Procedure to Return Product**1. Contact your service center.**

Describe the problem in as much detail as possible. Also describe what steps you took to try to correct the problem. In the case of a problem causing a System Malfunction alarm, be prepared to give the Error message displayed on the pump screen. Have available the serial number of the pump involved, and if possible, the date of purchase of that pump.

2. If the problem cannot be resolved, you will be assigned a Return Goods Authorization (RGA) number and asked to return the pump to your service center.

3. Clearly print your assigned Return Goods Authorization (RGA) number on the outside of the shipping package.

Important:

Before returning products, you must obtain a Return Goods Authorization (RGA) number. Products cannot be returned that do not have the assigned Return Goods Authorization (RGA) number clearly printed on the outside of the shipping package.

4. Ship the returned pump to the address given to you by your service center.

Important for Returns Within USA:

Due to Occupational Safety and Health Administration (OSHA) regulation 29 CFR Part 1910.1030 concerning bloodborne pathogens, contaminated product must be double-bagged, biohazard-labeled, and otherwise prepared per OSHA and U.S. Department of Transportation regulations.

WalkMed (“Manufacturer”) warrants to the person purchasing the infusion pump from Manufacturer (“Original Purchaser”) and only Original Purchaser that the infusion pump is free from defects in materials and workmanship under normal use, if used in accordance with the device operating instructions, **for one year from the date of sale to the Original Purchaser**. Subject to the conditions of and upon compliance with the procedures set forth in this limited warranty, the Manufacturer will repair or replace, at its option, any infusion pump, or part thereof, which has been actually received by the Manufacturer within the one year warranty period, and which examination discloses, to Manufacturer’s satisfaction, that the product is defective. Replacement product and parts are warranted only for the remaining portion of the original one year warranty period. This warranty does not apply to accessories and disposable items.

The following conditions, procedures, and limitations apply to the Manufacturer’s obligations under this warranty:

A. Parties Covered by this Warranty. This warranty extends only to the Original Purchaser of the infusion pump. This warranty does not extend to subsequent purchasers.

B. Warranty Performance Procedure. Notice of the defect must be made in writing to Customer Support Department, WalkMed LLC, 14190 E. Jewell Ave, Unit 10, Aurora, CO 80012, USA. Notice to WalkMed LLC must include the model and serial number, date of purchase, and description of the defect in sufficient detail to facilitate repairs. Authorization must be obtained by the Original Purchaser from the Manufacturer prior to returning the product to the Manufacturer. The defective pump must be properly packaged and returned to Manufacturer, postage-prepaid. Any loss or damage during shipment is at the risk of the Original Purchaser.

C. Conditions of Warranty. This warranty does not apply to any product, or part thereof, which has been repaired or altered outside of Manufacturer's facility in a way so as, in Manufacturer's judgment, to affect its stability or reliability, or which has been subjected to misuse, negligence or accident. Misuse includes, but is not limited to, use without compliance with the device operating instructions or use with non-approved accessories or disposable items.

D. Limitations and Exclusions. Repair or replacement of an infusion pump or component part is the EXCLUSIVE remedy offered by the Manufacturer.

The following exclusions and limitations shall apply:

- (1) No agent, representative, or employee of the Manufacturer has authority to bind the Manufacturer to any representation or warranty, expressed or implied, or to change this limited warranty in any way.
- (2) THIS LIMITED WARRANTY IS IN LIEU OF ALL OTHER WARRANTIES, EXPRESS OR IMPLIED, INCLUDING, BUT NOT LIMITED TO, WARRANTIES OF MERCHANTABILITY AND FITNESS FOR A PARTICULAR PURPOSE. THERE ARE NO WARRANTIES WHICH EXTEND BEYOND THE DESCRIPTION ON THE FACE HEREOF.
- (3) Manufacturer's liability under this Limited Warranty Agreement shall not extend to special, indirect, or consequential damages.
- (4) The infusion pump can only be used under the supervision of medical personnel whose skill and judgment determine the suitability of the infusion pump for a particular medical treatment.
- (5) All recommendations, information, and descriptive literature supplied by the Manufacturer or its agents are believed to be accurate and reliable, but do not constitute warranties.

This warranty, and the rights and obligations hereunder, shall be construed under and governed by the laws of the State of Colorado, USA.

Electromagnetic Emissions (Table 201, IEC 60601-1-2)

WalkMed infusion pumps are intended for use in the electromagnetic environment specified below. The customer or the user of these infusion pumps should assure that it is used in such an environment.

Guidance and manufacturers declaration – electromagnetic emissions

Emissions test	Compliance	Electromagnetic environment - guidance
RF emissions CISPR 11	Group 1	These WalkMed infusion pumps use 5 volt RF energy at 500 KHz for its internal function. Therefore, its RF emissions are very low and are not likely to cause any interference in nearby electronic equipment.
RF emissions CISPR 11	Class B	These infusion pumps are suitable for use in all establishments including domestic.
Harmonic emissions IEC 61000-3-2	Not Applicable	
Voltage fluctuations/ flicker emissions IEC 61000-3-3	Not Applicable	











Electromagnetic Immunity (Table 202 IEC 60601-1-2)

The WalkMed infusion pump is intended for use in the electromagnetic environment specified below. The customer or the user of the infusion pump should assure that it is used in such an environment.

**Guidance and manufacturers declaration –
electromagnetic immunity**

Immunity test	IEC 60601 test level	Compliance level	Electromagnetic Environment - guidance
Electrostatic discharge (ESD) IEC 61000-4-2 EN 60601-2-24	±8 kV contact ±15 kV air	±8 kV contact ±15 kV air	This device is a portable, 9-volt battery operated device intended for use in hospital or home environments as well as being carried by ambulatory patients.
Electrical fast transient/burst IEC 61000-4-4	±2 kV for power supply lines ±1 kV for input/output	Not applicable	
Surge IEC 61000-4-5	±1 kV line(s) to line(s) ±2 kV line(s) to earth	Not applicable	

Immunity test	IEC 60601 test level	Compliance level	Electromagnetic Environment - guidance
Voltage dips, short interruptions and voltage variations on power supply input lines IEC 61000-4-11	<5 % UT (>95 % dip in UT) for 0,5 cycle	Not applicable	
	40 % UT (60 % dip in UT) for 5 cycles		
	70 % UT (30 % dip in UT) for 25 cycles		
	<5 % UT (>95 % dip in UT) for 5 sec		
Power frequency (50/60 Hz) magnetic field IEC 61000-4-8	400 A/m	400 A/m	Intense static magnetic fields should be avoided as the product incorporates reed relays which could possibly be activated by an external magnetic field.
IEC 61000-4-3 Radiated RF Immunity	10V/m	10V/m	

	Caution
	Type BF Patient Applied Part
IPX-1	Drip Proof
	Do Not Re-use
STERILE EO	Ethylene Oxide Sterilized
	Use-by Date
LOT	Lot Number
	Manufacturer
EC REP	Authorized Representative
	Refer to Operator's Manual
	Do Not Resterilize
	Do Not Use if Package is Damaged
	Consult Instructions for Use
	Non-Pyrogenic
	Temperature Limits
REF	Catalog Number
SN	Serial Number

A

Access Code 35

(Code not available in the online Operation Manual)

Accessories, pump, 6

Accuracy of infusion, 9

Air-in-line detection,
caution, 12

Alarm:

conditions, 7, 48-49*display messages,* 7, 48-49*lights,* 7, 48-49*sounds,* 7, 48-49*recommended**corrective actions for,* 48-49

Ambulatory use of pump:

carrying pouch for, 40*caution,* 12-16*contraindication,* 11

Analgesics, infusion of, 11

Antibiotics, infusion of, 11

Arterial infusion, 11

Aseptic technique

for disposables,

caution, 15

Autoclaving, caution, 14

B

Bag. (See Reservoir bag)

Battery:

capacity, 9*compartment,* 4, 9*depleted battery alarm,* 48*low battery alarm,* 48*removal before**pump storage,* 41*specification,* 9*to insert,* 19*to remove,* 20Blood, infusion of,
contraindication, 11Bloodborne pathogens,
OSHA regulation
concerning (USA-only), 51**C**Carrying pouch: ,
how to use, 40Changing programmed
basal flow rate, 29Chemotherapeutic agents,
infusion of, 11

Clamp bar:

description of, 4-5*lock pin,* 4-5*open alarm,* 54*to close,* 23-24*to open,* 22*warning,* 13

Clamp bar lock pin:

description of, 4-5*in closing clamp bar,* 23-24

Cleaning and care of pump, 42

Contraindications for use,
list of, 11Control keys,
functions of, 8Corrective actions,
recommended, table of, 48-49Counter,
volume delivered 32

Cover.

See Front cover and Reservoir cover

- Critical medications,
infusion of, contraindication, 11
- D**
- Delivery of medications:
indications and
contraindications for, 11
specifications for, 9
precautions for, 12-16
- Depleted battery alarm, 48
- Dimensions of pump, 9
- Discontinuing use of pump, 41
- Display screen:
description of, 4-5, 7
messages, 48-49
- Disposable product labeling,
caution, 16
- E**
- Elastic tubing segment:
caution on twisting, 15
inserting into pump, 23
- Elbow fitting, of tubing, 23
- Enteral administration,
indication for use, 11
- Epidural administration,
indication for use, 11
- Error messages, 49
- Explosive gases,
use in presence of, caution, 12
- F**
- Flow rate, range, 9
verification test, 46
- Front cover:
description of, 5
to attach, 17
- to remove,* 17
use and storage, caution, 15
- Functional test procedures, 43
- Functional verification
 test, 43-45
- I**
- Indications for use, list of, 11
- Infusion:
accuracy of, 9
arterial, 11
continuous, 9
enteral, 11
epidural, 11
flow rate of, 9
intravenous, 11
of analgesics, 11
of antibiotics, 11
of blood, 11
of chemotherapeutic
agents, 11
of critical medications, 11
of insulin, 11
subcutaneous, 11
- Insulin, infusion of,
contraindication, 11
- Intravenous infusion, 11
- K**
- Keys, control, functions of, 8
- Keypad:
caution, 15
description of, 4-5
function table, 8

L

- Lights, signal:
description of, 4, 7
during alarm conditions, 48-49
during pump power-on, 28
See also Status light, Malfunction light

Locking the pump 35

(Code not available in the online Operation Manual)

Low battery alarm, 48

M

Magnetic fields,
effect on pump, caution, 12

Maintenance instructions,
caution, 13

Maintenance, 42

Malfunction light:
description of, 4, 7
during alarm conditions, 48-49

O

Occlusion:
alarm signal, 48
alarm caution, 12
detection, 10
sensitivity caution, 14

Operating environment, 10

OSHA regulation
concerning bloodborne pathogens (USA-only), 51

P

Patient instruction, caution, 16

Power key, function, 8

Power source, 9

Precautions, list of, 12-16

Pressure cell, of tubing set:
insertion into pump, 23
seat, 4-5, 23

Prime:
function of key, 8
to prime tubing set, caution, 12

Problem-solving:
if problem occurs, 47
table, 48-49

Value (Δ) key:
function of, 8
use to change and set flow rate, 29

Pump power:
key, 8
screen displays after power-on, 28
source, 9
to turn on, 28

Pump tubing path:
description of, 4-5
inserting tubing set into, 23

Pumping chamber:
description of, 4
inserting tubing set into, 23

Pumping mechanism, 9

- R**
- Rate of medication delivery:
 - during priming*, 36
 - programmable range of*, 9
 - to change*, 29-31
 - to set*, 29-31
 - Repair of pump:
 - caution*, 15
 - obtaining service assistance*, 50-51
 - Reservoir bag:
 - available sizes*, 9
 - medication interaction with caution*, 16
 - preparation of*, 21
 - to install*, 21-22
 - to remove*, 41
 - Reservoir cover:
 - hinges*, 18
 - description of*, 6
 - to close*, 18
 - to open*, 18
 - to remove*, 18
 - cover with lock*, 6
 - Returning contaminated product (USA-only), 51
 - Returning pump for service 51
 - Reviewing programmed pump settings,
 - caution*, 31
- S**
- Screen display:
 - description of*, 4, 7
 - messages during alarm conditions*, 48-49
 - messages during pump power-up*, 28
 - Service, 50-51
 - Self-test, pump, 28
 - Signals, pump:
 - alarm*, 48-49
 - description of*, 7
 - Slide clamp:
 - before opening clamp bar*, *caution*, 13
 - to close*, 41
 - Sounds, pump:
 - description of*, 7
 - during alarm conditions*, 48-49
 - Specifications of pump, 9
 - Start key, functions, 8
 - Status light:
 - description of*, 4, 7
 - during alarm conditions*, 48-49
 - during medication delivery*, 37
 - during pump power-on*, 28
 - Sterilization, caution, 14
 - Stop key, functions, 8
 - Subcutaneous infusion, 11
 - System malfunction alarm, 4, 49
 - Symbols, key to, 57

T

Technical description

electromagnetic emission 54*electromagnetic immunity* 55

Temperatures,

*for pump operation**and storage,* 10

Test procedures, 43

Tubing set:

*clamping before opening**clamp bar,* 13, 41*medication interaction with,*
caution, 16*preparation of,* 21*priming of,* 36*recommended set,*
caution, 14*specification,* 9*to install,* 21-24*to remove,* 41**U**

Uncontrolled fluid flow,

caution, 13

Unlocking the pump 35

***(Code not available in the online
Operation Manual)*****W**

Warranty, 52-53

Water,

*pump exposure to**caution,* 14

Weight of pump, 9



walkmed.net



Manufactured by: WalkMed, LLC

14190 E. Jewell Ave, Unit 10 • Aurora, Colorado

Telephone: (303) 420-9569 • Fax: (303) 420-4545 • walkmed.net